



Technical Specification

EC-Link Specification

Document No: TS-0007

REV	DATE	REASON FOR ISSUE	PREPARED BY	CHECKED BY	APPROVED BY
1	2016-11-01	First revision	JL	JTS	JL
2	2017-10-16	Updated during implementation	JL	OTE	JL
3	2018-31-07	Changed behavior of commands when armed/disarmed.	OTE	JL	GAØ
4	2020-05-12	Updated maximum POD bytes	GAØ	MS	GAØ
5	2020-10-21	Added Modbus TCP and VX-100-BU	JL	GAØ	GAØ
6	2020-12-21	Altered byte swap on Modbus TCP	JL	GAØ	GAØ
7	2021-02-04	Added EtherCAT support	JL	GAØ	GAØ

This document is proprietary and confidential. No part of this document may be disclosed in any manner to a third party without the prior written consent of Vision Remote AS.

Table of Contents

1	Introduction	4
1.1	Purpose.....	4
1.2	System Overview	4
1.3	Definitions and Abbreviations	4
1.4	Workflow.....	5
1.5	References	5
1.6	Revision History	6
2	General.....	7
2.1	Operational Mode	7
2.2	Value encoding	7
2.3	BU configuration	7
3	Profibus DP	8
3.1	Getting started guide	8
3.2	GSD file.....	8
3.3	Profibus DP Master Configuration.....	9
3.4	Setting Profibus address.....	9
3.5	Profibus interface.....	9
3.5.1	Operation Mode LED.....	9
3.5.2	Status LED	10
3.5.3	Profibus Connector	10
4	Profinet RT.....	11
4.1	Getting started guide	11
4.2	GSDML file	11
4.3	Profinet IO controller configuration	12
4.4	Setting station name and IP address	12
4.5	Profinet interface	12
4.5.1	Network Status LED.....	13
4.5.2	Module Status LED	13
4.5.3	Link/Activity LED	13
4.5.4	Profinet Connector.....	13
4.5.5	Media Redundancy	14
5	Modbus TCP.....	15
5.1	Getting started guide	15
5.2	Modbus TCP functionality	15
5.3	Setting IP configuration.....	16
5.4	Modbus TCP interface	17
5.4.1	Network Status LED.....	17
5.4.2	Module Status LED	17
5.4.3	Link/Activity LED	17
5.4.4	Ethernet Connector	18
6	EtherCAT.....	19
6.1	Getting started guide	19
6.2	ESI files.....	19

6.3	EtherCAT functionality	20
6.4	EtherCAT master configuration	20
6.5	EtherCAT interface	20
6.5.1	RUN LED.....	21
6.5.2	ERROR LED.....	21
6.5.3	Link/Activity LED	21
6.5.4	EtherCAT Connectors	21
7	Input data.....	22
7.1.1	BU state.....	23
7.1.2	Link status	23
7.1.3	RU state	23
7.1.4	RU joystick.....	24
7.1.5	Switch state	24
8	Output data	25
9	Data flow	26
9.1	Command input	26
9.2	Command output.....	27
9.3	Periodic input data	27
9.4	Periodic output data.....	27
9.5	Armed vs. Disarmed.....	28
9.6	G-Link fallback operation	29
10	Troubleshooting guide.....	29

1 Introduction

1.1 Purpose

This document specifies the fieldbus interface used for the VisionRemote EC-Link. This document covers the Profibus DP, Profinet RT, Modbus TCP and EtherCAT variants.

This document is valid both for VM-110-BU and VX-100-BU. The term BU is used for both.

Please note that data presented on the RU graphical screen and commands entered on graphical screen are handled by the RU application. The RU application is adapted to suit the actual machine. This document specifies how to exchange this data over EC-Link, but the actual data content must be specified in a machine specific document.

1.2 System Overview

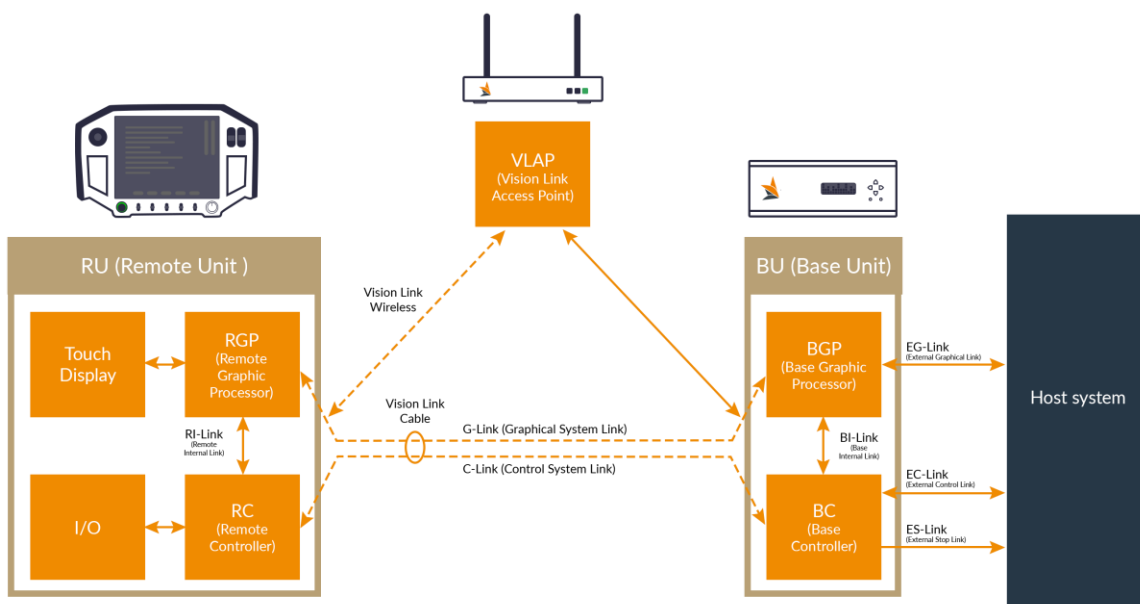

1.3 Definitions and Abbreviations

See system overview in section 1.2.

Machine controller is used for the computer or PLC that communicates with BU using the fieldbus interface specified in this document.

The term 'Input' is used for data sent from BU to machine controller. The term 'Output' is used for data sent from machine controller to BU. These terms are identical to PLC terms for dedicated peripheral units:

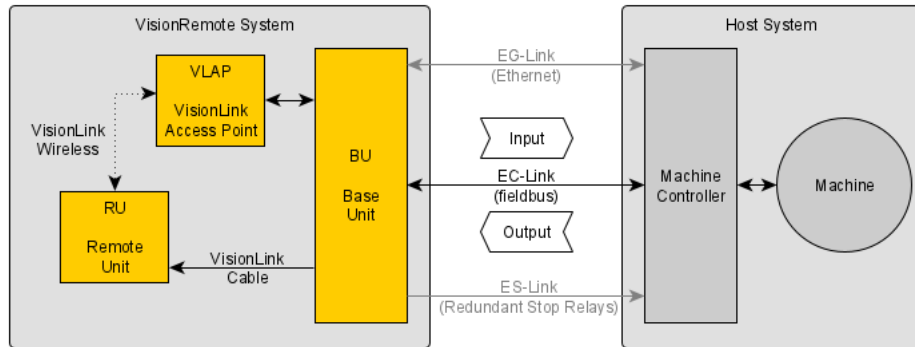

Input data is described in chapter 7. Output data is described in chapter 8.

1.4 Workflow

Typical workflow when developing a PLC application and an accompanying RU application is:

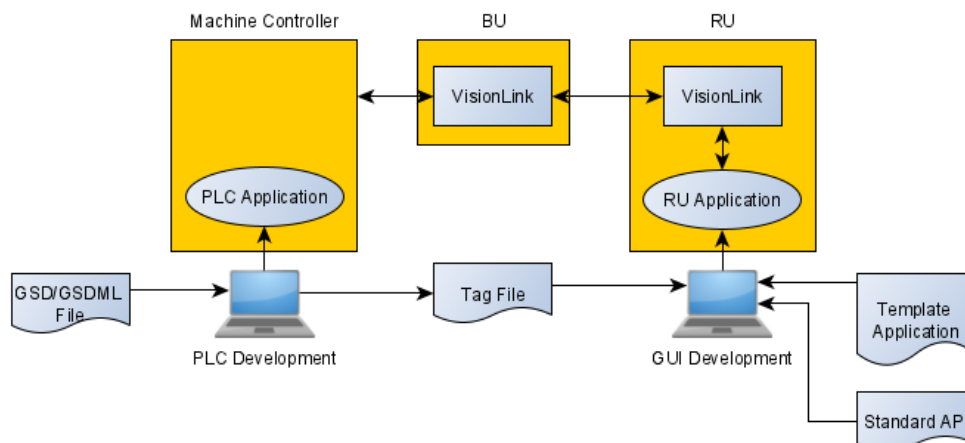

1.5 References

SS-0001 Vision Remote VM-110 System Specification

SS-0003 Vision Remote VX-100 System Specification

1.6 Revision History

Revision	Description
1	Initial revision.
2	Updated during implementation: <ul style="list-style-type: none">- Extended specification to cover both Profinet and Profibus.- Changed document name to cover both Profibus and Profinet.- Added description of different operational modes.- Extended values for RU state and Link state.
3	The behavior of the command messages when Armed and disarmed has been changed. Now commands are forwarded to all remotes regardless of arming state.
4	Corrected maximum bytes to 51200 in chapter 7.4
5	Added chapter 5 describing Modbus TCP interface. Specified that document covers both VM-110-BU and VX-100-BU. Renamed document accordingly.
6	Altered byte swapping on Modbus TCP to ensure full compatibility with standard.
7	Added chapter 6 describing EtherCAT interface.

2 General

2.1 Operational Mode

The fieldbus interface in BU can be configured for one of the following operational modes:

Mode	Description
Input Only	Inputs (status, joysticks, and switches) are transferred on fieldbus
Input + Commands	Inputs and commands from/to GUI application are transferred on fieldbus
Standard	Inputs, commands, and periodic data to GUI application transferred on fieldbus

The operational mode of your system is configurable, see section 2.3.

2.2 Value encoding

All multi bytes values are encoded in big-endian format (most significant byte first).

All data specified in this document uses one of the following encodings:

- Unsigned integer with a length of 8, 16 or 32 bits.
- Signed integer with a length of 8, 16- or 32-bits using two's complement.

All size values in this document are to be interpreted as bytes.

2.3 BU configuration

The BU is configured and managed using the built-in web server. Connect your computer to the BU network port labelled "TEST PORT" and open the web page at 192.168.32.1. The user interface will be specified in a separate document.

3 Profibus DP

3.1 Getting started guide

Depending on your system configuration, you can skip some of the steps in this guide:

Mode	Skip steps
Input Only	4,5,7 and 8
Input + Commands	5 and 8
Standard	None

To successfully integrate the BU in your Profibus system, do the following:

1. Add the BU to your Profibus master configuration. See section 3.3.
2. Configure Profibus address on BU. See section 2.3.
3. Connect BU to your Profibus network. See section 3.5.3.

At this stage, the Profibus is running, and data from BU is available in the machine controller. If your system is not of type "Input only", the BU will still indicate an error because it will not detect that the machine controller acknowledges and sends data to/from BU.

4. Add Software in machine controller to update CAO (Command Acknowledge Output), see section 9.1.
5. Add software in machine controller to update PCO (Periodic Counter Output), see section 9.4.

At this stage the BU will indicate normal operation.

6. Add software in machine controller to handle periodic data from RU.
7. Add software in machine controller to send commands to RU application and to handle commands from RU application.
8. Add software in machine controller to send periodic process data to RU application.
9. Enjoy.

3.2 GSD file

BU is delivered with a GSD file to be used when configuring the Profibus master.

3.3 Profibus DP Master Configuration

To add BU to your Profibus master, import the supplied GSD file into your Profibus master configuration tool. Use the configuration tool to add a node of type "VM-110-BU-DP".

Then add a single module depending on the operational mode of the BU:

Mode	Module to select	Input bytes	Output Bytes
Input Only	VM-110-BU Input Only	64	0
Input + Commands	VM-110-BU Input + Command	64	20
Standard	VM-110-BU Standard	64	224

3.4 Setting Profibus address

The Profibus address can be configured in two different ways:

- With an address in range 1 to 125 set as part of BU configuration. See section 2.3. This is the recommended solution.
- By using the "Set slave address" Profibus function. This function is enabled by selecting address 126 in BU configuration.

When using the "Set slave address" function, the BU configuration utility can be used to reset EC link configuration to factory default. This will reset the slave address to 126.

3.5 Profibus interface

The Profibus interface module is a Anybus CompactCom M40 module made by HMS Industrial Networks, part number AB6600.

Nr	Item
1	Operation Mode LED
2	Status LED
3	Profibus Connector, 9-pin female D-Sub

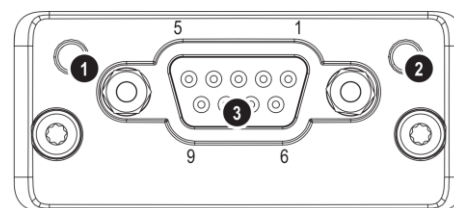

3.5.1 Operation Mode LED

State	Indication
Off	Not online / No power
Green	Online, data exchange
Flashing Green	Online, clear
Red, 1 Flash	Parametrization error
Red, 2 Flashes	Profibus Configuration error

3.5.2 Status LED

State	Indication
Off	Not initialized
Green	Initialized
Flashing Green	Initialized, diagnostic event(s) present
Red	Exception error

3.5.3 Profibus Connector

9-Pin D-Sub Female

Pin	Signal	Description
1	-	-
2	-	-
3	B-Line	Positive RxD/TxD, RS485 level
4	RTS	Request to send
5	GND Bus	Ground (isolated)
6	+5V Output	+5V termination power
7	-	-
8	A Line	Negative RxD/TxD, RS485 level
9	-	-
Housing	Cable Shield	Connected to protective earth

This layout is according to the industry standard for Profibus.

4 Profinet RT

4.1 Getting started guide

Depending on your system configuration, you can skip some of the steps in this guide:

Mode	Skip steps
Input Only	4,5,7 and 8
Input + Commands	5 and 8
Standard	None

To successfully integrate the BU in your Profinet system, do the following:

1. Add the BU to your Profinet controller configuration. See section 4.3.
2. Configure Profinet IP address and station name on BU. See section 2.3.
3. Connect BU to your Profinet network. See section 4.5.4.

At this stage, the Profinet is running, and data from BU is available in the machine controller. If your system is not of type "Input only", the BU will still indicate an error because it will not detect that the machine controller acknowledges and sends data to/from BU.

4. Add Software in machine controller to update CAO (Command Acknowledge Output), see section 9.1.
5. Add software in machine controller to update PCO (Periodic Counter Output), see section 9.4.

At this stage, the BU will indicate normal operation.

6. Add software in machine controller to handle periodic data from RU.
7. Add software in machine controller to send commands to RU application and to handle commands from RU application.
8. Add software in machine controller to send periodic process data to RU application.
9. Enjoy.

4.2 GSDML file

BU is delivered with a GSDML file to be used when configuring the Profinet controller.

4.3 Profinet IO controller configuration

To add BU to your Profinet controller, import the supplied GSDML file into your Profinet controller configuration tool. Use the configuration tool to add a node of type "VM-110-BU-PIR".

Then add modules depending on the operational mode of the BU:

Mode	Module in slot 1	Module in slot 2	Input bytes	Output Bytes
Input Only	Inputs	<none>	64	0
Input + Commands	Inputs	Command Outputs	64	20
Standard	Inputs	Standard Outputs	64	224

Set the station name configured into the BU in the controller configuration.

4.4 Setting station name and IP address

Use the Profinet controller configuration tool to program a unique station name into BU. If your system has multiple base units, each BU must have a unique station name.

There is normally no need to configure an IP address in BU. The Profinet controller assigns the IP address during startup using Profinet DCP.

4.5 Profinet interface

The Profinet interface module is a Anybus CompactCom M40 module made by HMS Industrial Networks, part number AB6605.

Nr	Item
1	Network Status LED
2	Module Status LED
3	Link/Activity LED (port 1)
4	Link/Activity LED (port 2)

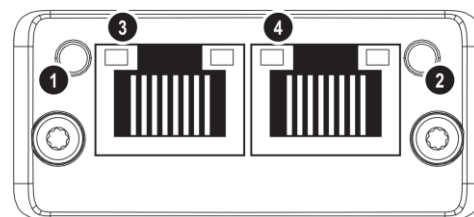

4.5.1 Network Status LED

State	Indication
Off	No power / No Connection with IO Controller
Green	Connection with IO controller established. IO controller in RUN state.
Green, 1 Flash	Connection with IO controller established. IO controller in STOP state or IO data bad. IRT synchronization not finished.
Green, Blinking	Used by engineering tools to identify the node on the network.
Red	Major internal error in module.
Red, 1 Flash	Station name is not set.
Red, 2 Flashes	IP address is not set.
Red, 3 Flashes	Configuration error. Expected Identification differs from Real Identification.

4.5.2 Module Status LED

State	Indication
Off	Module not initialized by application.
Green	Normal Operation.
Green, 1 Flash	Diagnostics event(s) present in module.
Red	Exception error/ Fatal event. Major internal error in module.
Green/Red alternating	Firmware update in progress. Do NOT power off the module

4.5.3 Link/Activity LED

State	Indication
Off	No Link established (not connected)
Green	Link established, no communication
Green, flickering	Link established, communication present

4.5.4 Profinet Connector

2 RJ45 connectors. The Ethernet interface operates at 100 Mbit, full duplex, as required by PROFINET.

Pin	Description
4,5,7,8	Connected to chassis ground over serial RC circuit
6	RD-
3	RD+
2	TD-
1	TD+
Housing	Cable shield

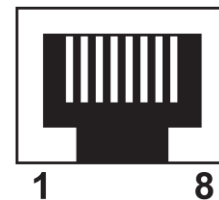

The shield of the RJ45 connector is not connected directly to Protective Earth in BU. For further information, see PROFINET Installation Guideline for Cabling and Assembly, available for download at www.profinet.com.

4.5.5 Media Redundancy

The Profinet interface module has 2 RJ45 network connectors and support the Media Redundancy Protocol (MRP) as a Media Redundancy Client (MRC).

5 Modbus TCP

5.1 Getting started guide

Depending on your system configuration, you can skip some of the steps in this guide:

Mode	Skip steps
Input Only	4,5,6,8 and 9
Input + Commands	6 and 9
Standard	None

To successfully integrate the BU in your system, do the following:

1. Set IP configuration of BU Modbus TCP interface. See section 5.3.
2. Connect BU to your network. See section 5.4.4.
3. Add Software in machine controller to periodically read input data from BU. See section 5.2.
4. Add Software in machine controller to periodically write output data to BU. See section 5.2.
5. Add Software in machine controller to update CAO (Command Acknowledge Output), see section 9.1.
6. Add software in machine controller to update PCO (Periodic Counter Output), see section 9.4.
At this stage, the BU will indicate normal operation.
7. Add software in machine controller to handle periodic data from RU.
8. Add software in machine controller to send commands to RU application and to handle commands from RU application.
9. Add software in machine controller to send periodic process data to RU application.
10. Enjoy.

5.2 Modbus TCP functionality

The Modbus TCP standard is available at <https://www.modbus.org/specs.php>. BU is a Modbus TCP server (slave) supporting up to 4 simultaneous connections.

BU supports all Modbus data types, and they access the BU input and output data like this:

Modbus data type	Input data mapping	Output data mapping
Coils		Bitwise mapping: Bit 0 is LSbit of first byte (byte 0) Bit 1791 is MSbit of last byte (byte 223)

Discrete Inputs	Bitwise mapping: Bit 0 is LSbit of first byte (byte 0) Bit 511 is MSbit of last byte (byte 63)	
Holding Registers	16-bit register mapping: Register 2048 is byte 0 and 1. Register 2079 is byte 62 and 63.	16-bit register mapping: Register 0 is byte 0 and 1. Register 111 is byte 222 and 223.
Input Registers	16-bit register mapping: Register 0 is byte 0 and 1. Register 31 is byte 62 and 63.	

8-bit values are transferred with two bytes in one register. First byte is in the lower 8 bits. 16-bit values are transferred in big-endian format, as specified by the Modbus-TCP standards.

5.3 Setting IP configuration

BU Modbus TCP interface must be configured with a valid IP configuration. The recommended method is to use a tool named HMS IPconfig. This tool can be downloaded free of charge from the HMS website: <http://anybus.com>

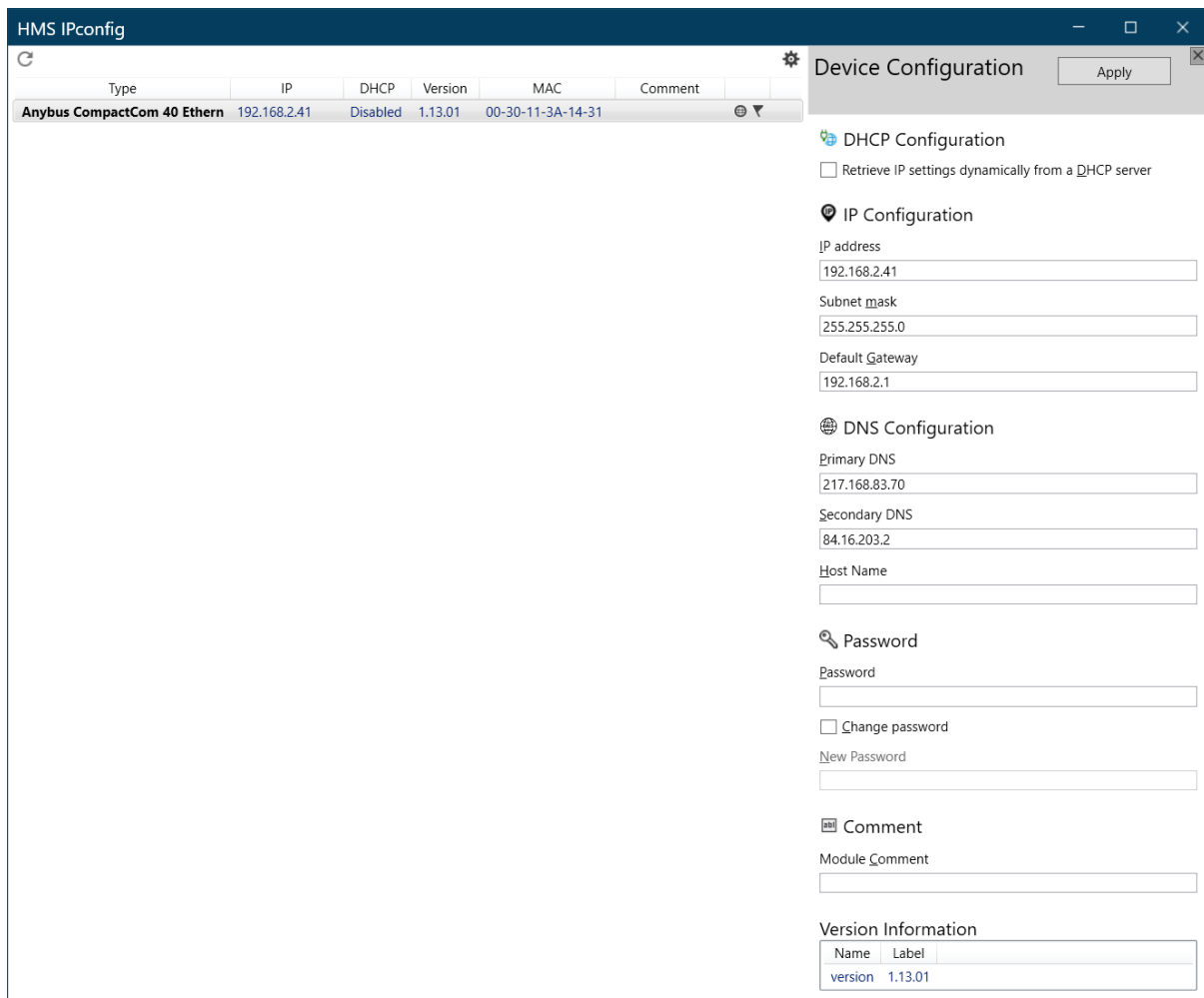

5.4 Modbus TCP interface

The Modbus TCP interface module is a Anybus CompactCom M40 module made by HMS Industrial Networks, part number AB6603.

Nr	Item
1	Network Status LED
2	Module Status LED
3	Link/Activity LED (port 1)
4	Link/Activity LED (port 2)

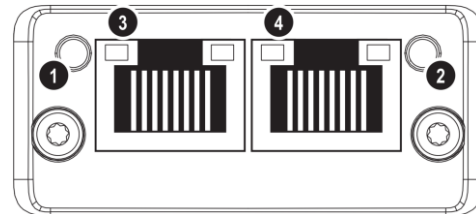

5.4.1 Network Status LED

State	Indication
Off	No IP address or in state EXCEPTION.
Green	At least one Modbus message received.
Green, flashing	Waiting for first Modbus message.
Red	IP address conflict detected, FATAL ERROR.

5.4.2 Module Status LED

State	Indication
Off	Module not initialized by application.
Green	Normal Operation.
Red	Exception error/ Fatal event. Major internal error in module.
Red, flashing	Minor fault
Green/Red alternating	Firmware update in progress. Do NOT power off the module

5.4.3 Link/Activity LED

State	Indication
Off	No Link established (not connected)
Green	Link established, 100 Mbit, no communication
Green, flickering	Link established, 100 Mbit, communication present
Yellow	Link established, 10 Mbit, no communication
Yellow, flickering	Link established, 10 Mbit, communication present

5.4.4 Ethernet Connector

2 RJ45 connectors. The Ethernet interfaces supports 100 Mbit or 10 Mbit, full or half duplex.

Pin	Description
4,5,7,8	Connected to chassis ground over serial RC circuit
6	RD-
3	RD+
2	TD-
1	TD+
Housing	Cable shield

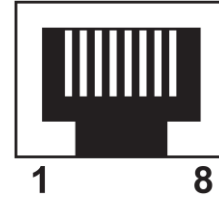

The shield of the RJ45 connector is AC coupled to PE connector on BU.

6 EtherCAT

6.1 Getting started guide

Depending on your system configuration, you can skip some of the steps in this guide:

Mode	Skip steps
Input Only	3,4,5 and 7
Input + Commands	4 and 7
Standard	None

To successfully integrate the BU in your EtherCAT system, do the following:

1. Add the BU to your EtherCAT master configuration. See section 6.4.
2. Connect BU to your EtherCAT network. See section 6.5.4.

At this stage, the EtherCAT communication is running, and data from BU is available in the machine controller. If your system is not of type "Input only", the BU will still indicate an error because it will not detect that the machine controller acknowledges and sends data to/from BU.

3. Add Software in machine controller to update CAO (Command Acknowledge Output), see section 9.1.
4. Add software in machine controller to update PCO (Periodic Counter Output), see section 9.4.

At this stage, the BU will indicate normal operation.

5. Add software in machine controller to handle periodic data from RU.
6. Add software in machine controller to send commands to RU application and to handle commands from RU application.
7. Add software in machine controller to send periodic process data to RU application.
8. Enjoy.

6.2 ESI files

BU is delivered with a set of ESI files to be used when configuring the EtherCAT master.

6.3 EtherCAT functionality

The EtherCAT interface supports the following features:

- CANopen over EtherCAT (CoE), Complete access support
- DS301 compliant
- Network cycle time down to 100µs
- 4 FMMUs, 4 Sync managers
- Support for position addressing, node addressing and logical addressing

For further details regarding EtherCAT implementation, see Anybus document “SCM-1202-034, Anybus CompactCom 40 EtherCAT Network Guide”.

16-bit values are transferred in big-endian format, as specified by the EtherCAT standards.

6.4 EtherCAT master configuration

To add BU to your EtherCAT master, import the supplied ESI files into your EtherCAT master configuration tool. The node to add depends on the operational mode of the BU:

Mode	Node name	Input bytes	Output Bytes
Input Only	VR-BU-ECT-Map1	64	0
Input + Commands	VR-BU-ECT-Map3	64	20
Standard	VR-BU-ECT-Map7	64	224

6.5 EtherCAT interface

The EtherCAT interface module is a Anybus CompactCom M40 module made by HMS Industrial Networks, part number AB6607.

Nr	Item
1	RUN LED
2	ERROR LED
3	EtherCAT IN port
4	EtherCAT OUT port
5	Link/Activity LED IN port
6	Link/Activity LED OUT port

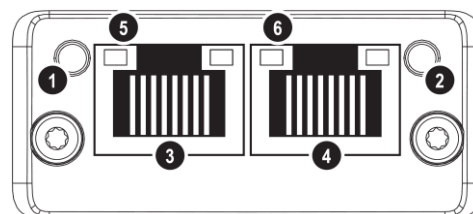

6.5.1 RUN LED

This LED reflects the status of the EtherCAT device.

State	EtherCAT device state
Off	INIT
Green	OPERATIONAL
Green, Blinking	PRE-OPERATIONAL
Green, Single flash	SAFE-OPERATIONAL
Flickering	BOOT
Red	If RUN and ERROR turn red, this indicates a fatal event, forcing the bus interface to a physically passive state.

6.5.2 ERROR LED

State	Indication
Off	No error (or no power)
Red, Blinking	Invalid configuration. State change received from master is not possible due to invalid register or object settings.
Red, Single flash	Unsolicited state change. Slave device application has changed the EtherCAT state autonomously.
Red, Double flash	Sync Manager watchdog timeout
Red	If RUN and ERROR turn red, this indicates a fatal event, forcing the bus interface to a physically passive state.
Flickering	Booting error detected, E.g. due to firmware download failure.

6.5.3 Link/Activity LED

State	Indication
Off	Link not sensed (or no power)
Green	Link sensed, no traffic activity
Green, flickering	Link sensed, traffic detected

6.5.4 EtherCAT Connectors

Pin	Description
4,5,7,8	Connected to chassis ground over serial RC circuit
6	RD-
3	RD+
2	TD-
1	TD+
Housing	Cable shield

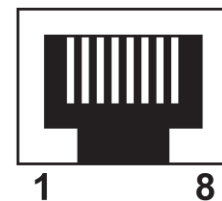

The shield of the RJ45 connector is AC coupled to PE connector on BU.

7 Input data

Input data means data sent from BU to machine controller. The layout is like this:

Field	Offset [Bytes]	Size [Bytes]	Description
PCI	0	1	Periodic Counter Input. Incremented by BU each time new data is available. See section 9.3.
CCI	1	1	Command Counter Input. Incremented by BU when a new command has been received from the armed RU application. See section 9.1.
PAI	2	1	Periodic Acknowledge Input. Used to acknowledge that periodic data has been processed by BU. See section 9.4.
CAI	3	1	Command Acknowledge Input. Used to acknowledge that a command to RU application has been processed by BU. See section 9.2.
Command from RU	4	16	Command received from RU application.
BU state	20	1	State of BU. See section 7.1.1.
VLAPs	21	1	Number of VLAPs connected to BU. In range 0..3.
Unarmed RUs	22	1	Number of unarmed RUs communicating with this BU.
EG-Link status	23	1	State of EG-Link. See section 7.1.2.
EC-Link status	24	1	State of EC-Link. See section 7.1.2.
C-Link status	25	1	State of C-Link. See section 7.1.2.
Armed RU	26	2	Unique ID of RU that is currently armed. Set to 0 if no remote is currently armed. When 0, all the following fields are set to 0.
RU state	28	1	State of RU. See section 7.1.3.
RU battery	29	1	RU battery level in range 0..100 (%).
RU C-Link RSSI	30	1	RSSI level of C-Link in range 0..100 (%).
RU cable	31	1	Set to 0 if operating on wireless VisionLink. Set to 1 if operating on cable.
RU docked	32	1	Set to 1 when RU is in docking station. Otherwise 0.
RU disabled	33	1	Set to 0 if remote is enabled. Set to 1 if disabled due to tilting. Set to 2 if disabled due to inactivity. Set to 3 if disabled by other causes.
RU joystick 1 to 4	34	4 * 2	Position of joystick 1 to 4. See section 7.1.4.
RU switch 1 to 8	42	8 * 2	State of switch 1 to 8. See section 7.1.5.
RU encoder value	58	1	Encoder value. Is incremented and decremented as encoder is rotated. Wraps around freely, so machine controller must handle this if needed.
RU encoder switch	59	1	Set to 1 when encoder is pushed down. 0 if not.
Spare	60	4	Spare bytes for future use. Set to 0 for now.

7.1.1 BU state

The following BU state values are defined:

Value	Interpretation
0x00	Initial. BU is not fully operative yet.
0x01	Stopped. BU is armed against a specific RU, and RU signals that BU should stop.
0x02	External link error. Monitoring has detected an error in EC-Link or EG-Link.
0x03	Blocked. Communication is lost with an armed RU. Turn on RU and rearm to resume operation.
0x04	Failed. Self-diagnostics has discovered a fatal internal error in BU.
0x10	Disarmed. BU is not armed against a specific RU. Check 'Unarmed RUs' to see if any unarmed RUs are connected.
0x11	Armed. BU is armed against a specific RU.

The ES-Link relays will be open when BU state is less than 0x10.

7.1.2 Link status

The following link state values are defined:

Value	Interpretation
0	Unused. The link is not used in this system.
1	Operational. The link operates normally.
2	No Link. Link is not operational because no valid data has been received.
3	Link error. Configuration error in system causes link to be inoperative.
4	Interface Error. Error reported by link interface module.
5	Data error. Link is up, but there is an error in the exchanged data.
6	Passive. Link is not in use. Can only be reported on C-Link when no remote is armed.

7.1.3 RU state

The following RU state values are defined:

Value	Interpretation
0	Initial. No RU is armed yet.
1	Disarmed. Only used internally.
2	Armed. Remote is armed, but movements are disabled due to tilting or inactivity.
3	Enabled. Remote is armed and enabled. Movements are allowed.
4	Stopped. Armed remote has stopped causing ES-Link relay to open.

RU enters stopped state if one of the following happens while the RU is armed:

- Stop switch is activated

- Free fall or shock sensor is triggered
- A fatal error has occurred in RU

7.1.4 RU joystick

Joystick position as a signed integer in range +/- 1000. A passive joystick is reported as 0.

Single axis joysticks are oriented like this:



Dual axis joysticks are oriented like this:

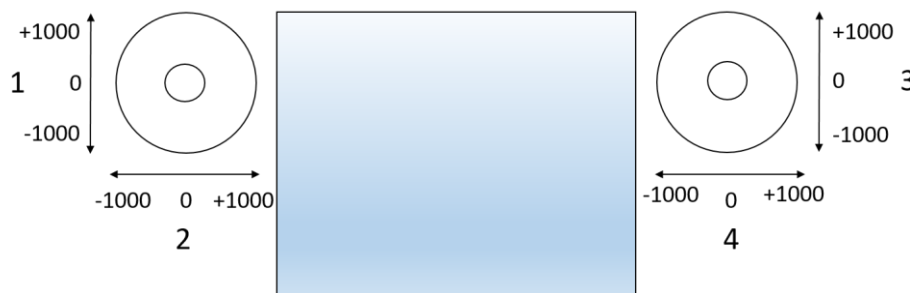

7.1.5 Switch state

Note that the protocol and the electronics are prepared for up to 8 switch positions. The RU has room for 4 switches if it is equipped with a stop switch, and 5 if not. The switches are numbered from left to right.

The value reported in switch state varies with the fitted switch:

Equipment	Value reported
Pushbutton	1 if button is pushed. 0 if not.
2-position toggle switch	1 if switch is in upper/right position. 0 if not.
3-position toggle switch	0 in center position. 1 in upper/right position. -1 in lower/left position.
Potentiometer	0 in counterclockwise position, up to 1000 in clockwise most position.
Pushbutton with LED	0 means not pushed. 1 means pushed. Add 2 if LED is lit.
Dual color LED	0 means OFF. 1 means GREEN. 2 means RED. 3 means AMBER.

When fitted with LEDs, the LEDs are controlled by the RU application. If the machine controller shall control these LEDs, functionality must be implemented in RU application to forward this data to the LEDs.

8 Output data

Output data means data sent from machine controller to BU. The layout is like this:

Field	Offset	Size	Description
PCO	0	1	Periodic Counter Output. Shall be incremented by machine controller each time new data is available. See section 9.4.
CCO	1	1	Command Counter Output. Shall be incremented by machine controller when a new command shall be sent to the armed RU. See section 9.2.
PAO	2	1	Periodic Acknowledge Output. Not used yet.
CAO	3	1	Command acknowledge Output. Used to acknowledge that a command from RU has been processed. See section 9.1.
Command to RU	4	16	Command to be sent to RU application.
Periodic data size	20	2	Number of bytes of process data to be transferred to RU application
Periodic data block	22	1	Data block number of this process data. Starting from 0.
Spare	23	1	Spare byte for future use. Set to 0 for now.
Periodic data	24	200	Periodic data to be sent to RU application.

9 Data flow

9.1 Command input

When the operator executes a command on GUI (e.g. presses a "start" button or alters a set-point), a command is sent from RU application to machine controller. BU increments CCI to tell that a new command is available.

The machine controller should implement command handling logic like this:

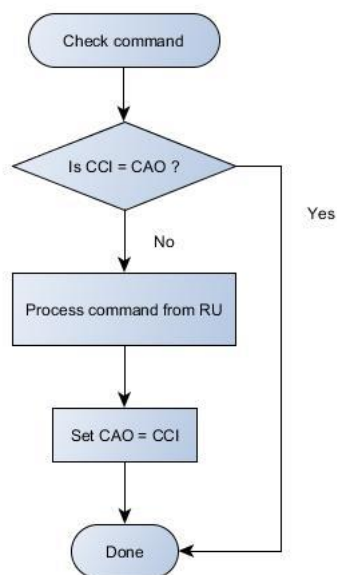

BU monitors CAO and indicates an error if a command has not been acknowledged for 2000ms. If this error occurs when an RU is armed, the ES-Link relays will open, and the machine is forced to a safe state.

Note that it is up to the RU application and the machine controller to decide on the data content in the 16 bytes that forms a command.

Also note that an RU may send commands when not armed. The RU application must be designed so it does not send commands that may interfere with an armed remote when it is not armed.

9.2 Command output

When machine controller needs to send a command to RU application, it should implement logic like this:

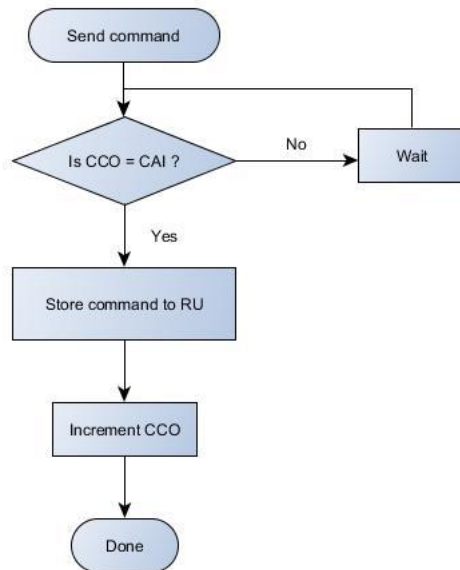

It is up to the machine controller and RU application to decide on the data content in the 16 bytes that forms a command. If your application does not need to send any commands, then just leave CCO at the default value.

9.3 Periodic input data

BU updates the input data every 125ms, and then increments PCI. The machine controller shall monitor PCI and bring the system to a safe state if PCI stops incrementing. A suitable timeout is 500ms.

9.4 Periodic output data

Periodic output data typically contains machine state values and measurement parameters. It is up to the RU application and the machine controller to agree on the interpretation of this data.

The machine controller shall update the periodic data to RU and increment PCO periodically.

BU monitors PCO and indicates an error if this value has not been incremented for 2000 ms. If this error occurs when an RU is armed, the ES-Link relays will open.

The machine controller shall write the size of the periodic data to be transferred to RU application. If this number is higher than 200, the machine controller must multiplex the data like this:

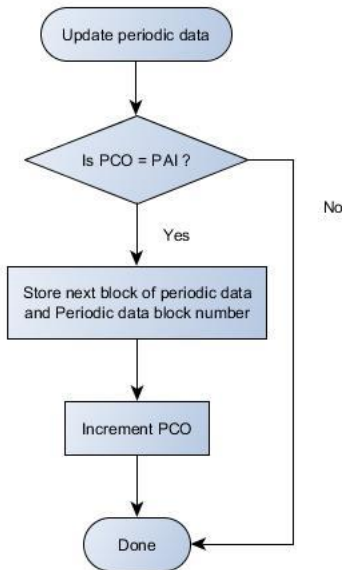

EC-Link handles up to 51200 bytes of periodic output data. (200 bytes * 256 blocks)

9.5 Armed vs. Disarmed

The BU handles multiple connected RUs simultaneously, but only one of them can be armed.

Data	When remote is armed	When remote is disarmed
Periodic Input	Data from remote is sent.	No data from remote is sent, but number of remotes is reported.
Periodic Output	Data from machine controller is sent to RU application.	Data from machine controller is sent to RU application.
Command Input	Commands from RU application are sent to machine controller.	Commands from RU application are sent to machine controller.
Command Output	Commands from machine controller are sent to RU application.	Commands from machine controller is sent to RU application.

9.6 G-Link fallback operation

Wireless G-Link is based on WiFi, so a limited operational range and occasional dropouts must be expected. When G-Link fails, the system will use C-Link instead. C-Link is more reliable but has limited capacity. When operating on C-Link, data will be prioritized like this:

Priority	Data	Description
1	Periodic Input	This data is important for machine control and system safety.
2	Command Input	Operator commands are more important than display updates.
3	Command Output	Critical alarms can be sent to RU application as commands to ensure priority over Periodic Output.
4	Periodic Output	Periodic update of graphical display data has lowest priority.

As seen by the operator, the system will be operative with a failing G-Link, but the response time on screen commands will be longer, and the periodic update of screen information will be slower.

When a RU is armed, fallback operation is limited to this RU. If no remote is armed, fallback will work on a single disarmed RU only.

10 Troubleshooting guide

Any errors in the EC-Link causes BU to be locked in initial state, and normal operation is not possible. The LCD display on BU shows the EC link error state like this:

Message	Troubleshooting
EC: No Data	No data exchanged on fieldbus. Check machine controller configuration and connection between BU and machine controller.
EC: Cfg. Error	Configuration mismatch between machine controller and BU.
EC: Module Error	Error in fieldbus interface module.
EC: Bad data	Fieldbus is configured correctly, and data exchange is operative. The machine controller fails to increment PCO periodically or to acknowledge commands from RU application using CAO, see chapter 8.